

Microswitch
Schnappschalter
Micro-rupteurs
Microinterruttore
Microrruptor

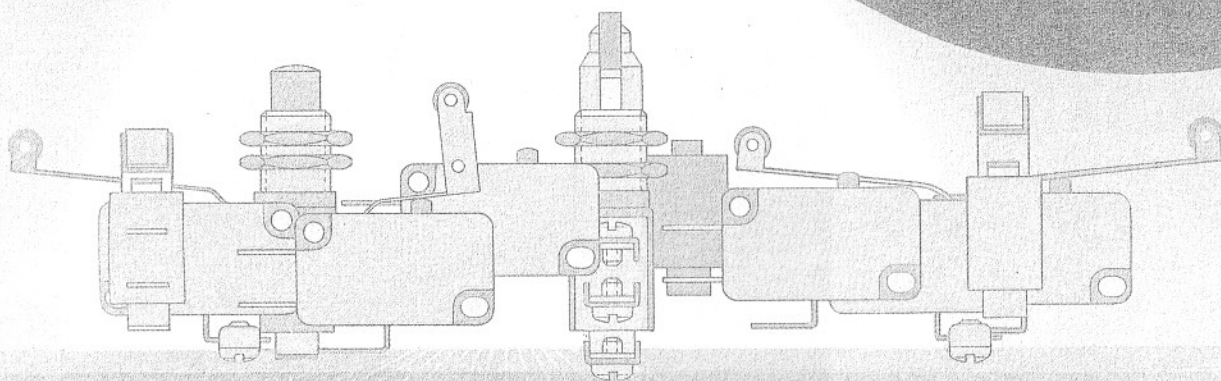

MICROSTOP
MOD. 27

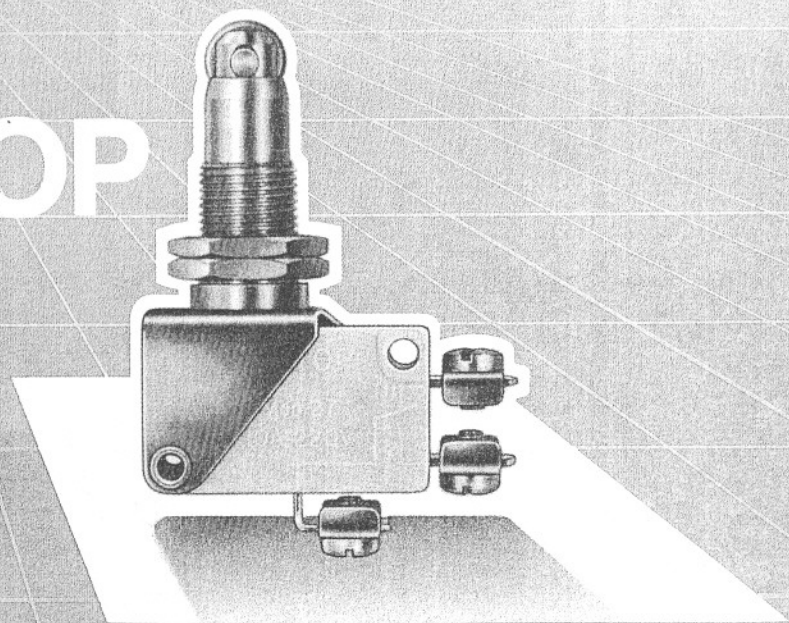

RALUX

LEVER - HEVEL LEVIER - LEVA PALANCA	Screw Schraube Vis A vite Tornillo	Faston	Soldering Lötbar A souder A saldare Soldable
Short - Kurz - Court Corta (C)	TPC	FPC	SPC
Middling - Mittel - Moyen Media - Mediana (M)	TPM	FPM	SPM
Long - Lang - Lunga Larga (L)	TPL	FPL	SPL
Short - Kurz - Court Corta (C)	TRC	FRC	SRC
Middling - Mittel - Moyen Media - Mediana (M)	TRM	FRM	SRM
Long - Lang - Lunga Larga (L)	TRL	FRL	SRL
Short - Kurz - Court Corta (C)	TBC	FBC	SBC
Middling - Mittel - Moyen Media - Mediana (M)	TBM	FBM	SBM
Long - Lang - Lunga Larga (L)	TBL	FBL	SBL

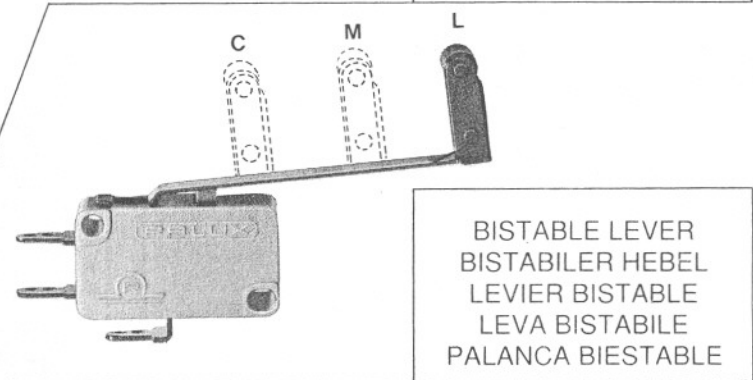
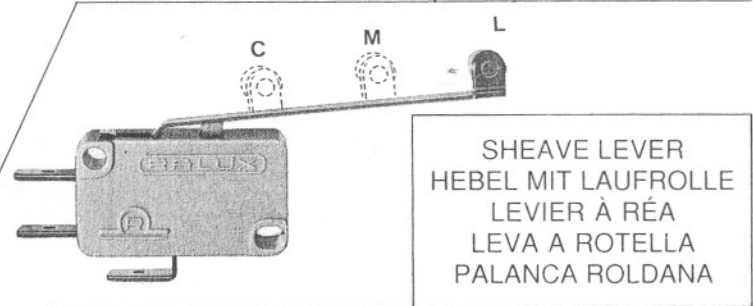
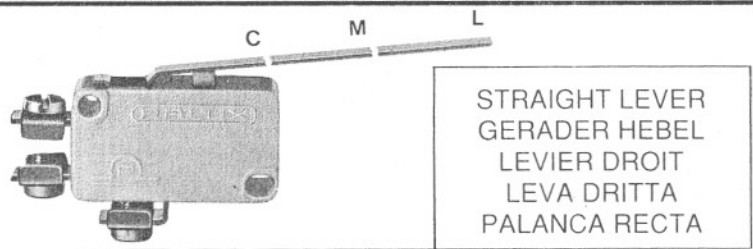

DEFINITION - BEZEICHNUNG - DÉFINITION - DEFINIZIONE - DEFINICION

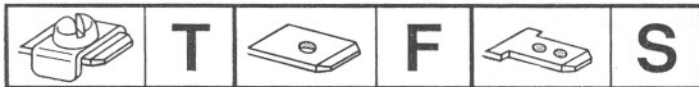

PUSH - BUTTON	Screw	TP	Faston	FP	Soldering	SP
TASTSCHALTER	Schraube	TP	Faston	FP	Lötbar	SP
POUSSOIR	Vis	TP	Faston	FP	À souder	SP
PULSANTE	A vite	TP	Faston	FP	A saldare	SP
PULSADOR	Tornillo	TP	Faston	FP	Soldable	SP

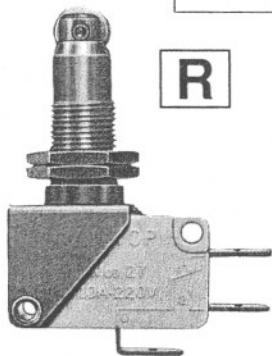
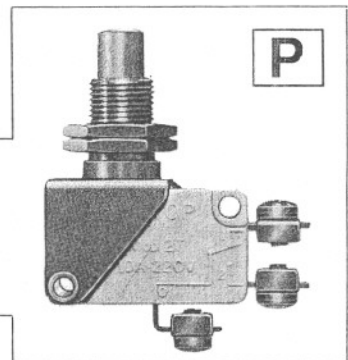

SHEAVE PUSH-BUTTON	Screw	TR	Faston	FR	Soldering	SR
LAUFROLLEN-TASTSCHALTER	Schraube	TR	Faston	FR	Lötbar	SR
POUSSOIR À RÉA	Vis	TR	Faston	FR	À souder	SR
PULSANTE A ROTELLA	A vite	TR	Faston	FR	A saldare	SR
PULSADOR ROLDANA	Tornillo	TR	Faston	FR	Soldable	SR

TURNUED SHEAVE PUSH-BUTTON	Screw	TRV	Faston	FRV	SRV	Soldering	SR
TASTSCHALTER FÜR VERDREHTE LAUFROLLE	Schraube	TRV	Faston	FRV	SRV	Lötbar	SR
POUSSOIR À RÉA VIRÉ	Vis	TRV	Faston	FRV	SRV	À souder	SR
PULSANTE A ROTELLA GIRATA	A vite	TRV	Faston	FRV	SRV	A saldare	SR
PULSADOR ROLDANA VIRADA	Tornillo	TRV	Faston	FRV	SRV	Soldable	SR

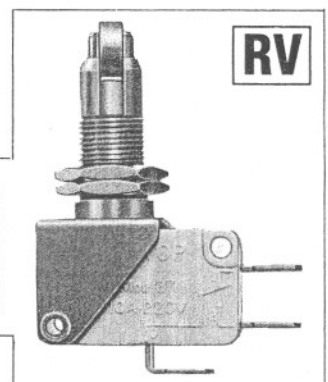

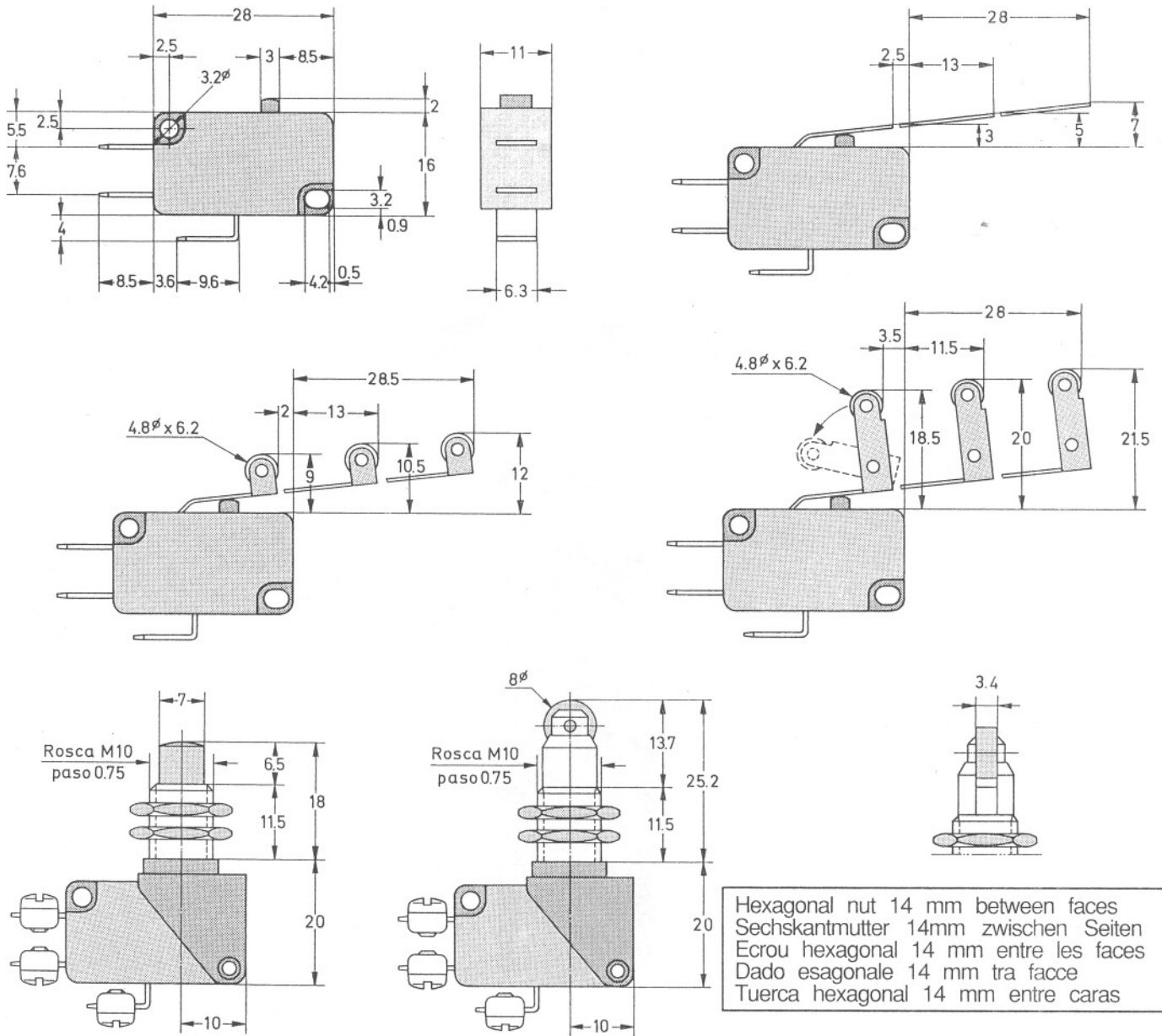

ACCESSORIES - ZUBEHÖR - ACCESSOIRES ACCESSORI - ACCESORIOS

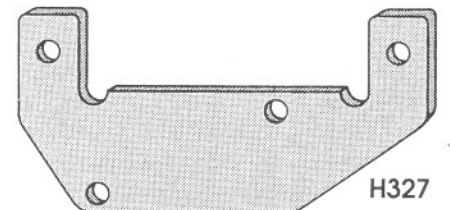
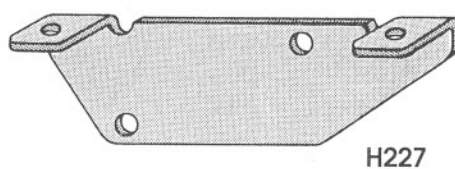
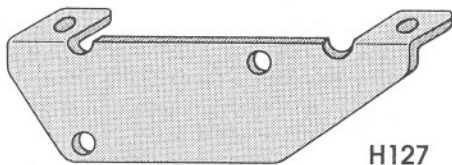

Insulator
 Isolierend
 Isolant
 Isolante
 Aislante

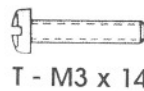
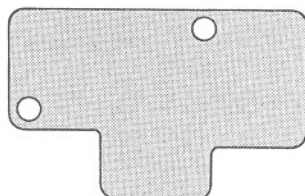

Screw - Schraube
 Vis - vite - Tornillo



Washer-Unterlagscheibe
 Rondelle-Rondella-Arandela



Nut - Mutter - Ecrou
 Dado - Tuerca



MOUNTING METHODS - ANBAUSYSTEME - SYSTEMES DE MONTAGE SISTEMI DI MONTAGGIO - SISTEMAS DE MONTAJE

Versions - Ausführungen - Versioni
Versiones

H127A, H127B, H127C, H227A, H227B
H227C, H327A, H327B, H327C, H327D

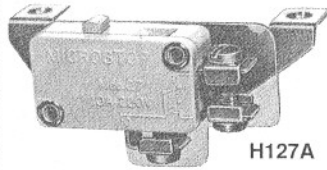

H127A

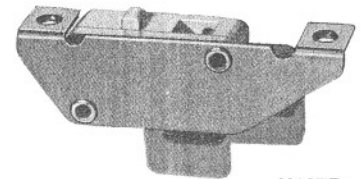

H127B

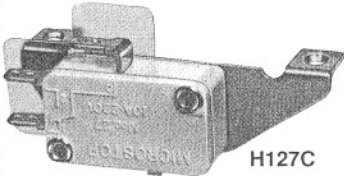

H127C

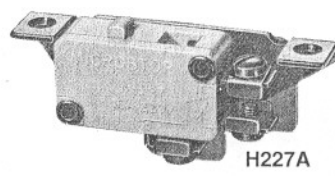

H227A

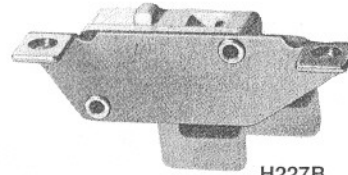

H227B

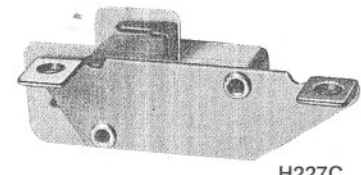

H227C

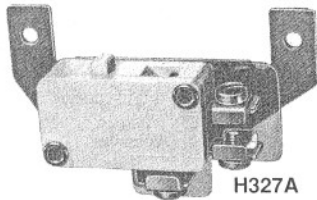

H327A

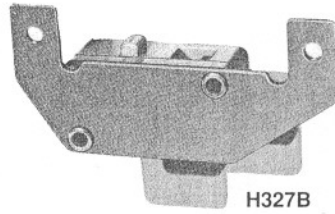

H327B

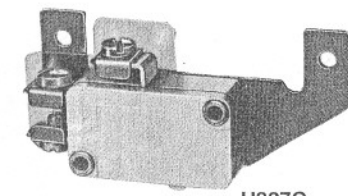

H327C

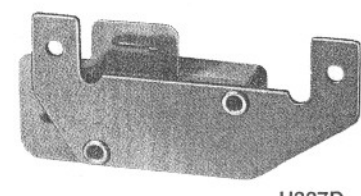

H327D

All versions of this series are available with levers, sheaves, bistables, push-buttons, sheave push-buttons or turned sheave push-buttons provided for soldering, Faston or screw-on connecting methods. They come equipped with an insulator plate placed between the accessory and the micro-switch, from the factory.

Alle Versionen dieser Serie können mit Hebeln, Rollen, Bistabil, Bedienungsknöpfen, Rollknöpfen, Drehknöpfen und mit geschweissten Faston-Anschlussystemen oder Klemmen geliefert werden. Sie werden ab Werk montiert und mit Isolierplatte zwischen dem Zubehör und dem Mikro-schalter geliefert.

Toutes les versions de cette série sont disponibles avec leviers, réas, bistables, poussoirs, poussoirs à réa viré et avec systèmes de connexion à souder, Faston ou à bornes. Elles sont aussi livrées de l'usine munies d'une plaque isolante placée entre l'accessoire et le micro-rupteur.

Tutte le versioni di questa serie si possono fornire con leva, rotelle, bistabili, a pulsante, con pulsante a rotella o pulsante a rotella girata e con sistemi di connessione a saldare, Faston o serratilo. Dalla fabbrica si consegnano montati con piastra isolante tra l'accessorio ed microinterruttore.

Todas las versiones de esta serie se pueden suministrar con palancas, roldanas, biestables, pulsadores, pulsadores roldana o pulsadores roldana virada y con sistemas de conexión a soldadura Faston o bornes. De fábrica se suministran montados con placa aislante entre el accesorio y el microinterruptor.

H127A	Angular accessory with backward fastening wings and the microswitch in front side - Übereck-Anbaustück mit Befestigungschenkel nach hinten und Mikrostop vorne - Accessoire coudé avec les ailes de sujétion vers l'arrière et le micro-rupteur en face - Accessorio angolare con alette di ritegno all'indietro e il Microinterruttore davanti - Accesorio angular con alas de sujeción hacia atrás y el Microstop delante.
H127B	Angular accessory with backward fastening wings and the microswitch in back side - Übereck-Anbaustück mit Befestigungschenkel nach hinten und Mikrostop hinten - Accessoire coudé avec les ailes de sujétion vers l'arrière et le micro-rupteur derrière - Accessorio angolare con alette di ritegno all'indietro e il Microinterruttore dietro - Accesorio angular con alas de sujeción hacia atrás y el Microstop detrás.
H127C	Angular accessory with backward fastening wings and the microswitch inversed in front side - Übereck-Anbaustück mit Befestigungschenkel nach hinten und Mikrostop vorne umgekehrt - Accessoire coudé avec les ailes de sujétion vers l'arrière et le micro-rupteur en face inversé - Accessorio angolare con alette di ritegno all'indietro e il Microinterruttore davanti invertito - Accesorio angular con alas de sujeción hacia atrás y el Microstop delante invertido.
H227A	Angular accessory with forward fastening wings and the microswitch in front side - Übereck-Anbaustück mit Befestigungschenkel nach vorne und Mikrostop vorne - Accessoire coudé avec les ailes de sujétion vers l'avant et le micro-rupteur en face - Accessorio angolare con alette di ritegno davanti e il Microinterruttore davanti - Accesorio angular con alas de sujeción hacia delante y el Microstop delante.
H227B	Angular accessory with forward fastening wings and the microswitch in back side - Übereck-Anbaustück mit Befestigungschenkel nach vorne und Mikrostop hinten - Accessoire coudé avec les ailes de sujétion vers l'avant et le micro-rupteur derrière - Accessorio angolare con alette di ritegno davanti e il Microinterruttore dietro - Accesorio angular con alas de sujeción hacia delante y el Microstop detrás.
H227C	Angular accessory with forward fastening wings and the microswitch inversed in back side - Übereck-Anbaustück mit Befestigungschenkel nach vorne und Mikrostop hinten umgekehrt - Accessoire coudé avec les ailes de sujétion vers l'avant et le micro-rupteur derrière inversé - Accessorio angolare con alette di ritegno davanti e il Microinterruttore dietro invertito - Accesorio angular con alas de sujeción hacia delante y el Microstop detrás invertido.
H327A	Angular accessory with upward fastening wings and the microswitch in front side - Übereck-Anbaustück mit Befestigungschenkel nach oben und Mikrostop vorne - Accessoire coudé avec les ailes de sujétion vers le haut et le micro-rupteur en face - Accessorio angolare con alette di ritegno in alto e il Microinterruttore davanti - Accesorio angular con alas de sujeción hacia arriba y el Microstop delante.
H327B	Angular accessory with upward fastening wings and the microswitch in back side - Übereck-Anbaustück mit Befestigungschenkel nach oben und Mikrostop hinten - Accessoire coudé avec les ailes de sujétion vers le haut et le micro-rupteur derrière - Accessorio angolare con alette di ritegno in alto e il Microinterruttore dietro - Accesorio angular con alas de sujeción hacia arriba y el Microstop detrás.
H327C	Angular accessory with upward fastening wings and the microswitch inversed in front side - Übereck-Anbaustück mit Befestigungschenkel nach oben und Mikrostop vorne umgekehrt - Accessoire coudé avec les ailes de sujétion vers le haut et le micro-rupteur en face inversé - Accessorio angolare con alette di ritegno in alto e il Microinterruttore davanti invertito - Accesorio angular con alas de sujeción hacia arriba y el Microstop delante invertido.
H327D	Angular accessory with upward fastening wings and the microswitch inversed in back side - Übereck-Anbaustück mit Befestigungschenkel nach oben und Mikrostop hinten umgekehrt - Accessoire coudé avec les ailes de sujétion vers le haut et le micro-rupteur derrière inversé - Accessorio angolare con alette di ritegno in alto e il Microinterruttore dietro invertito - Accesorio angular con alas de sujeción hacia arriba y el Microstop detrás invertido.