

JACK

China No.1

Shanghai stock
listed



MÁQUINA RECUBRIDORA
MÁQUINA DE RECOBRIMENTO

JK-W4-D RECUBRIDORA DE 3 AGUJAS CON BASE PLANA RECUBRIMENTO DE 3 AGULHAS COM BASE PLANA

JK-W4D-01 Máquina recubridora de 3 agujas con base plana. Equipada con sistema de recubrimiento superior e inferior y motor DIRECT DRIVE.

JK-W4D-01 Máquina de recobrimento de 3 agulhas com base plana. Equipada com sistema de recobrimento superior e inferior, e motor DIRECT DRIVE.

JK-W4D-08 Máquina recubridora de 3 agujas con base plana. Equipada con 4 equipos de costura: normal, collarines, morrongado y dobladillos. Motor DIRECT DRIVE.

JK-W4D-08 Máquina de recobrimento de 3 agulhas com base plana. Equipada com 4 equipamentos de costura: normal, collorètes, recobrimento e bainhas. Motor DIRECT DRIVE.

JK-W4D-05 Máquina recubridora de 3 agujas con base plana. Equipada con dispositivo regulador de tensión de puntilla y cortador derecho de tela. Motor DIRECT DRIVE.

JK-W4D-05 Máquina de recobrimento de 3 agulhas com base plana. Equipada com dispositivo de regulação de tensão cortador de renda e tecido direito. Motor DIRECT DRIVE.

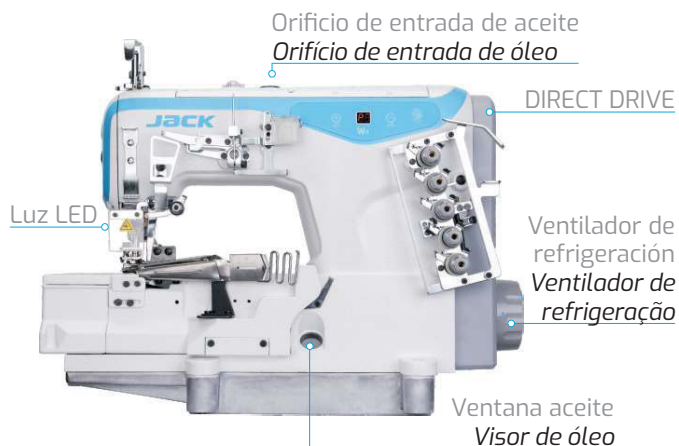

Corte de hilo automático
Corte de linha automático











Fácil cambio de equipos de costura
Fácil de trocar os equipamentos de costura



Regulador de puntilla
Regulador de renda



Diseño integrado
Desenho incorporado

				 (mm)	 (mm)			 (mm)	 (r.p.m)
JK-W4-D-01GB		3	5	5.6-6.4	1.5-4.5	0.65-1.3		7	5500
JK-W4-D-08		3	5	5.6-6.4	1.5-4.5	0.65-1.3		7	5500
JK-W4-D-05CB		3	5	5.6-6.4	1.5-4.5	0.65-1.3		5	5500
JK-W4-UTE-01		3	5	5.6-6.4	1.5-4.5	0.65-1.3	✓	7	5500

Consultar otras distancias entre agujas.
Consulte outras distâncias entre agulhas.

JK-K4-D RECUBRIDORA ELECTRÓNICA CON BASE CILÍNDRICA

RECOBRIMENTO ELETRÔNICA COM BASE CILÍNDRICA

Recubridora de base cilíndrica con o sin cortahilos. Equipada con sistema de recubrimiento superior e inferior y motor DIRECT DRIVE.

Recobrimento de base cilíndrica com ou sem corte de linha. Equipada com sistema de recobrimento superior e inferior e motor DIRECT DRIVE.

JK-K4-UT-01 Cortahilos y alzaprensatelas eléctricos.

JK-K4-UT-01 Corte de linha e levantamneto de calcador elétrico.

JK-K4-UTL-01 Cortahilos y alzaprensatelas neumáticos.

JK-K4-UTL-01 Corte de linha e levantamneto de calcador pneumático .

JK-K4-UTL-35 Cortahilos neumático superior e inferior, cuchilla a la izquierda para recortar el sobrante del tejido y alzaprensatelas. Equipada con electroválvula y saco desperdicios.

JK-K4-UTL-35 Corte de linha pneumático superior e inferior lâmina à esquerda para aparar o excesso de tecido e levantamento de calcador. Equipado com electroválvula e saco desperdícios.

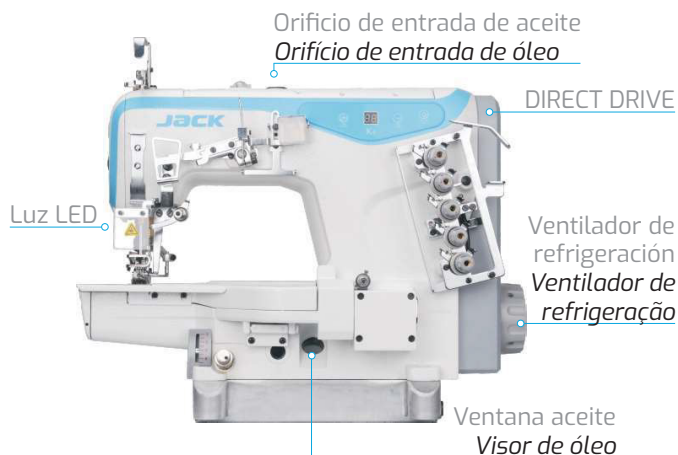

Cortahilos superior
Corte de linha superior











Distintos grosores
Diferentes espessuras



Instrucciones por voz
Instruções por voz



Barra de aguja lubricada
Barra de agulha lubrificada

			 (mm)	 (mm)			 (mm)	 (r.p.m)
JK-K4-D01GB	3	5	5.6-6.4	1.5-4.5	0.8-1.3		7	5500
JK-K4-UT-01GB	3	5	5.6-6.4	1.5-4.5	0.8-1.3	✓	7	5500
JK-K4-UTL-01GB	3	5	5.6-6.4	1.5-4.5	0.8-1.3	✓	7	5500
JK-K4-UTL-35GB	3	5	5.6-6.4	1.5-4.5	0.8-1.3	✓	7	5500

JK-8670DI RECUBRIDORA BASE CILÍNDRICA CORTAHILOS RECOBRIMENTO BASE CILÍNDRICA CORTE DE LINHA

Máquina recubridora con base cilíndrica, súper reducida (diámetro de 177 cm) con cortahilos superior e inferior, alzaprensatelas neumático y motor DIRECT DRIVE.

Máquina de recobrimento com base cilíndrica, super reduzida (177 cm de diâmetro) com corte de linha superior e inferior, levantamento de calcador pneumático e motor DIRECT DRIVE.

JK-8670DI-01-UT Máquina recubridora de 3 agujas. Equipada con sistema de recubrimiento superior e inferior y motor **eléctrico**.

JK-8670DI-01-UT Máquina de recobrimento de 3 agulhas. Equipada com sistema de recobrimento superior e inferior e motor elétrico.

JK-8670DI-01-UTL Máquina recubridora de 3 agujas. Equipada con sistema de recubrimiento superior e inferior y motor **neumático**.

JK-8670DI-01-UTL Máquina de recobrimento de 3 agulhas. Equipada com sistema de recobrimento superior e inferior e motor pneumático.

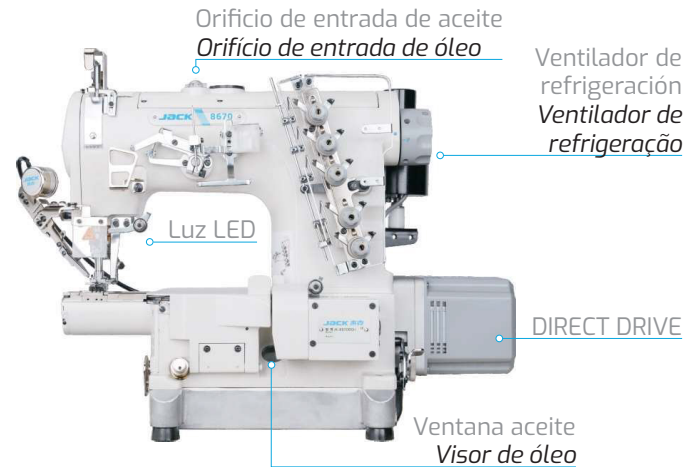

Diámetro pequeño
Diâmetro pequeno











Corte de hilo automático
Corte de linha automático



Leva de hilo desplazada
Came da linha deslocada



Motor integrado
Motor incorporado

			 (mm)	 (mm)			 (mm)	 (r.p.m)
JK-8670DI-01CB	3	5	5.6-6.4	1.5-3.6	0.8-1.4		6,2	4500
JK-8670DI-01CB/UT	3	5	5.6-6.4	1.5-3.6	0.8-1.4	✓	6,2	4500
JK-8670DI-01CB/UTL	3	5	5.6-6.4	1.5-3.6	0.8-1.4	✓	6,2	4500

JK-8009 CADENETA MULTI AGUJAS PONTO CADEIA MULTI-AGULHAS

Máquina multiaguja de cadeneta cilíndrica y motor DIRECT DRIVE.

Máquinas multi-agulhas de ponto de cadeia cilíndricas e motor DIRECT DRIVE.

JK-8009VCDI-12 Máquina de 12 agujas cadeneta cilíndrica.

JK-8009VCDI-12 Máquina de 12 agujas ponto de cadeia cilíndrica.

JK-8009VC-25-32P Máquina de 25 agujas cadeneta cilíndrica.

JK-8009VC-25-32P Máquina de 25 agujas ponto de cadeia cilíndrica.

JK-8009VCDI-12/UTL Máquina de 12 agujas cadeneta cilíndrica, cortahilos y alzaprensatelas neumático. Consultar modelos para cantidad de agujas y distancia entre agujas.

JK-8009VCDI-12/UTL Máquina de 12 agujas ponto de cadeia cilíndrica, corte de linha, levantamento de calcador pneumático. Consulte o modelo para quantidade de agujas e distância entre agujas.

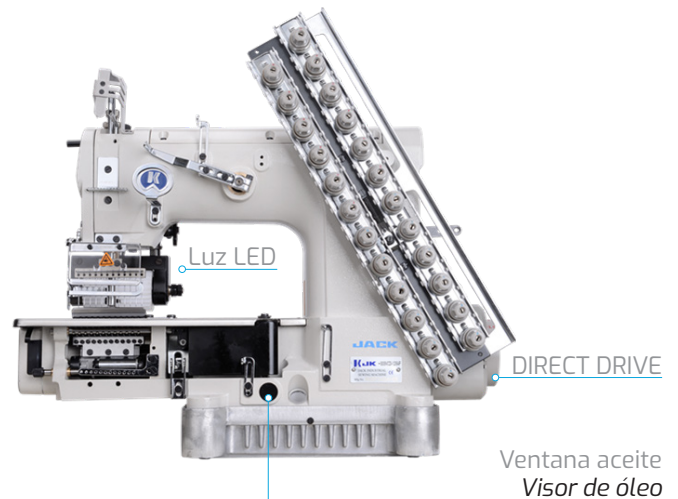

Fijación elástica
Fijación elástica

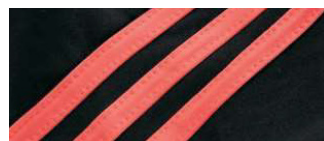

Cinta de fijación
Cinta de fijación



Delante camisa
Delante camisa



Banda de cintura
Banda de cintura

JK-8009VCDI-12064P	12	24	1/8", 3/16", 1/4"	1.5-3.6	0.8-1.4			8	3500
JK-8009VCDI-12064PR	12	24	1/8", 3/16", 1/4"	1.5-3.6	0.8-1.4			8	3500
JK-8009VCDI-25064P	25	50	1/8"	1.5-3.6	0.8-1.4			8	3500

Opciones:

PR - puler liso de goma.
P - puler estriado de teflón.

Opções:

PR - puler liso de borracha.
P - puler estriado de teflón.



Jack Sewing Machine Co.,LTD

Distribuidor

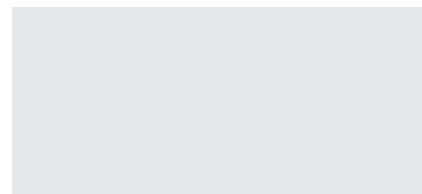

VENDEDOR

Jack Sewing Machine Co.,LTD

No. 15 South Airport Road, Jiaojiang District, Taizhou, Zhejiang, PRC

Tel: 0086-576-88177782 88177767

Fax: 0086-576-88177787

www.chinajack.com

IMPORTADOR

J. Pujol Maquinaria Confección S.A.

Pol. Ind. Les Pedreres Sector "B"
C/ Indústria, 5 08390 MONTGAT (BCN), SPAIN

Tel: (+34) 93 351 16 11

sat@jpujol.com

Fax: (+34) 93 340 12 21

www.jpujol.com